

Formation Conditions of Clathrates Between HFC Alternative Refrigerants and Water¹

T. Akiya,² T. Shimazaki,² M. Oowa,² M. Matsuo,³ and Y. Yoshida^{3,4}

There are two promising candidates as alternative refrigerants for air-conditioners and heat pumps. The first is R407C, which is composed of HFC-32 (23 mass%), HFC-125 (25 mass%), and HFC-134a (52 mass%). The second is R410A, which is composed of HFC-32 (50 mass%) and HFC-125 (50 mass%). In this study, formation conditions of clathrate compounds between water and HFC alternative refrigerants such as HFC-32, HFC-125, HFC-134a, and their mixtures, R407C and R410A, were investigated. Phase diagrams of clathrates of these HFC alternative refrigerants and their mixtures were determined. From the phase diagrams, the critical decomposition temperature and the critical decomposition pressure were determined. The relationship between the critical decomposition points for the clathrates of HFC-32, HFC-125, HFC-134a, R410A, and R407C were studied. It is found that R407C and R410A form clathrate compounds with water under the evaporating temperature condition in the refrigeration cycle of air-conditioners and heat pumps.

KEY WORDS: clathrate compounds; critical decomposition point; HFC-32; HFC-125; HFC-134a; R407C; R410A; refrigeration cycle; water.

1. INTRODUCTION

There are two promising candidates as alternative refrigerants [1] for air-conditioners and heat pumps. These are mixtures composed of hydrofluorocarbons (HFCs). The first is R407C, which is composed of

¹ Paper presented at the Thirteenth Symposium on Thermophysical Properties, June 22–27, 1997, Boulder, Colorado, U.S.A.

² System Analysis Laboratory, Department of Chemical Systems, National Institute of Materials and Chemical Research, 1-1, Higashi, Tsukuba, Ibaraki 305, Japan.

³ Human Environment Research Laboratory, Matsushita Electric Industrial Co., Ltd., 3-1-1, Yagumo-Nakamachi, Moriguchi, Osaka 570, Japan.

⁴ To whom correspondence should be addressed.

23 mass% of HFC-32 (CH_2F_2 ; difluoromethane), 25 mass% of HFC-125 (CF_3CHF_2 ; pentafluoroethane), and 52 mass% of HFC-134a ($\text{CF}_3\text{CH}_2\text{F}$; 1,1,1,2-tetrafluoroethane), and is a nonazeotropic mixture. The second is R410A, which is composed of 50 mass% of HFC-32 and 50 mass% of HFC-125 and is a near-azeotropic mixture.

The presence of clathrate compounds has been confirmed in the part under the evaporating pressure condition of a refrigeration unit using R407C and R410A [2]. So the formation conditions of clathrate compounds between R407C/R410A as alternative refrigerants and water should be investigated. Clathrates are known to have ice-like structure, which are comprised of HFC refrigerants as guest molecules and water as host molecules [3].

Among HFC refrigerants, there are very limited sources of data. Some patents [4] reveal HFC-32, HFC-125, and HFC-134a form clathrates with water but do not describe the formation conditions. As for HFC-32, only the critical decomposition temperature (T_C) of the clathrate between HFC-32 and water was reported in the literature [3] as 17.6°C (290.75 K), which was cited from a report in 1890. Formation conditions of the clathrate between HFC-134a and water were investigated [5], and a critical decomposition temperature (T_C) of 283.20 K and a critical decomposition pressure (P_C) of 0.415 MPa were found. Information on the clathrate between HFC-125 and water was not found. There are three kinds of crystal structures in clathrates, which are structures I, II [3], and H [6]. The different structures of the clathrates are mainly caused by the guest molecular sizes [3]. It is reported that HFC-32 forms crystals of structure I [3]. HFC-125 and HFC-134a are expected to form crystals of structure II based on their molecular sizes.

In this study, HFC-32, HFC-125, HFC-134a, and their mixtures, R407C and R410A, were investigated. Phase diagrams of clathrates between these HFC refrigerants and water were determined. The critical decomposition temperature, the critical decomposition pressure, and the enthalpy of dissociation of these clathrates were determined from the phase equilibria of the refrigerant clathrates. The relationships among the critical decomposition points for the clathrates of HFC-32, HFC-125, HFC-134a, R410A, and R407C were studied.

2. MEASUREMENTS

The experimental apparatus used in this study is shown in Fig. 1. A glass cell (cell volume was 10^{-3} m^3) made of Pyrex glass was immersed in a temperature-controlled water bath. The stirrer with four blades (diameter of $4.7 \times 10^{-2} \text{ m}$) was placed at the center of the flange. The temperature in

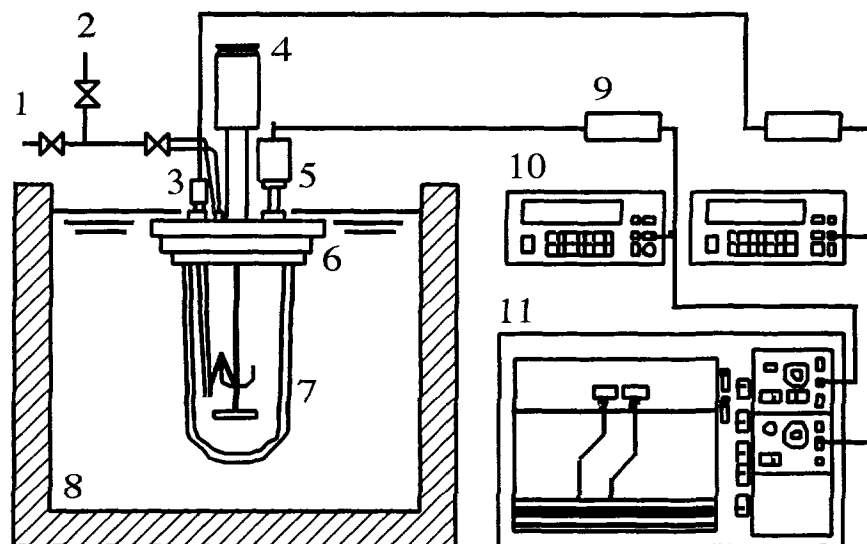

- | | |
|---|---------------------------------------|
| 1 : To Refrigerant Cylinder | 2 : To Vacuum |
| 3 : Platinum Resistance Thermometer | 4 : Stirrer |
| 5 : Strain Gauge Type Pressure Transducer | 6 : Flange |
| 7 : Glass Cell | 8 : Temperature Controlled Water Bath |
| 9 : Amplifier | 10 : Digital Voltmeter |
| | 11 : Recorder |

Fig. 1. Experimental apparatus.

the cell was measured by a platinum resistance thermometer, an amplifier, and a digital voltmeter. The pressure was measured by a strain gauge type pressure transducer, an amplifier, and a digital voltmeter.

The certified purities of refrigerants HFC-32, HFC-125, and HFC-134a were better than 99.9, 99.5, and 99.9 mass%, respectively. The certified purities of the mixed refrigerants R407C and R410A were 99.98 and 99.97 mass%, respectively. The certified composition of R407C was 23.05/24.94/52.01 mass% of HFC-32/HFC-125/HFC-134a. The certified composition of R410A was 50.37/49.63 mass% of HFC-32/HFC-125. These refrigerants were used without any further purification. The water (700 g) used in these experiments was deionized.

Experimental procedures were as follows. Regardless of whether single or mixed refrigerants were being studied, after the weighed deionized water had been charged into the glass cell, the glass cell was degassed by a rotary vacuum pump. Then, some amounts of the refrigerant were charged into the glass cell, and the glass cell was degassed again by the rotary vacuum

pump. Finally, known amounts of each refrigerant were charged into the glass cell and mixed with the degassed water. The glass cell was immersed in a temperature-controlled water bath, and the mixture of the refrigerant and the deionized water was cooled to the desired temperature, with agitation, until the clathrate formed. The temperature change and the pressure change of the mixture of the water and the refrigerant were recorded to confirm the equilibrium state. After the temperature and the pressure in the glass cell had become stable, i.e., when no changes in recorded values were observed over about 3 h for single refrigerants and over about 5 h for mixed refrigerants, the temperature and the pressure values were taken as equilibrium data using digital voltmeters. The relationship between the temperature and the pressure before the formation of clathrate represents the condensation line. After the clathrate has formed, the temperature of the water bath was set to the next desired temperature. The mixture of the refrigerant, the water, and the clathrate was heated, with agitation, until the clathrate disappeared. The relationship between the temperature and

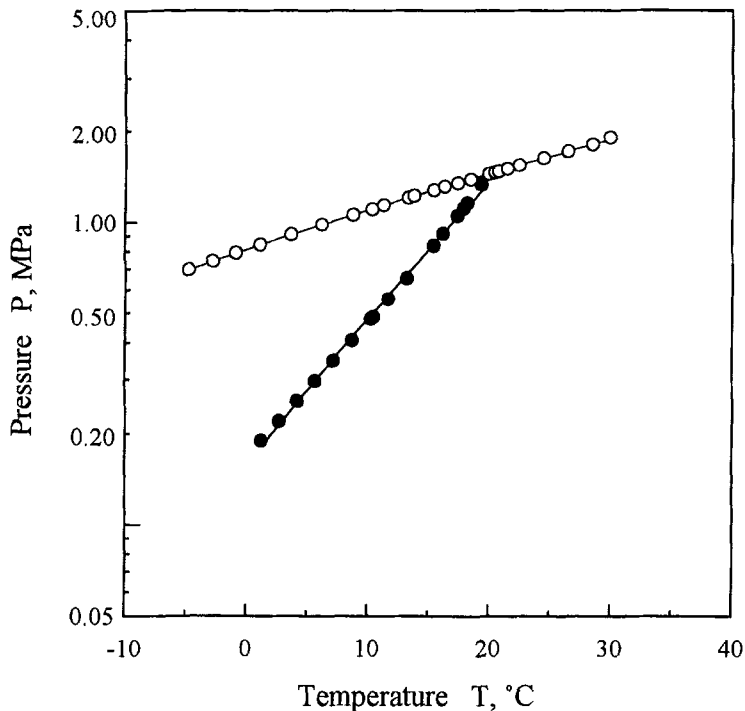

Fig. 2. Phase equilibrium of the HFC-32/water system.

the pressure until the clathrate disappears represents the clathrate formation line. The uncertainties of temperature and pressure measurements were estimated to be within ± 15 mK and $\pm 0.1\%$, respectively.

3. RESULTS FOR SINGLE REFRIGERANTS

The phase equilibrium of the HFC-32/water system is shown in Fig. 2 with a logarithmic pressure scale and linear temperature scale. In this figure, the points \circ represent the condensation line under the coexistence of the vapor phase and the liquid phase of HFC-32 and the water. The obtained values of this experimental condition agree well with the saturation line calculated using REFPROP Version 5.0 [7]. The points \bullet represent the clathrate formation line under the coexistence of the vapor phase of HFC-32 and the water, and the liquid phase of the water and the clathrate. The phase equilibria of the HFC-125/water and the HFC-134a/water systems are shown in Figs. 3 and 4, respectively.

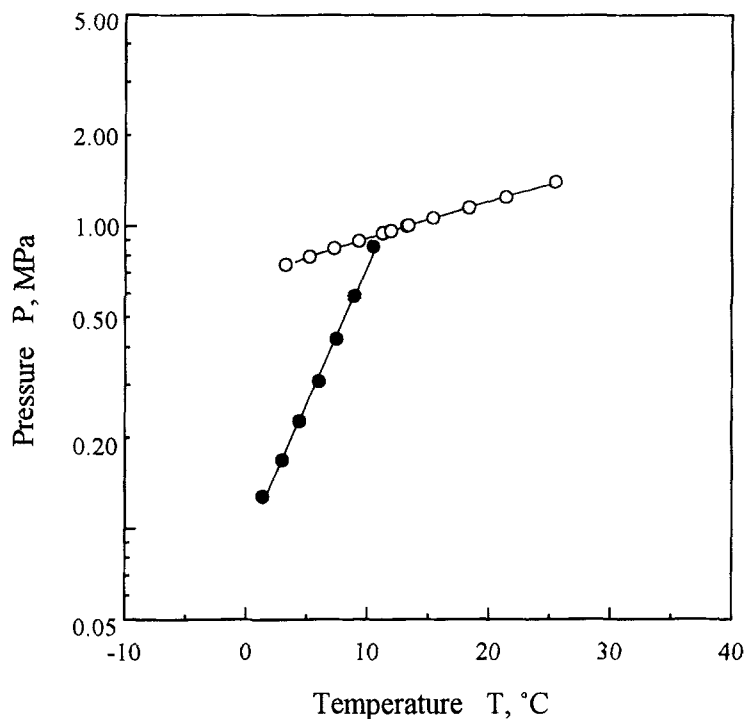

Fig. 3. Phase equilibrium of the HFC-125-water system.

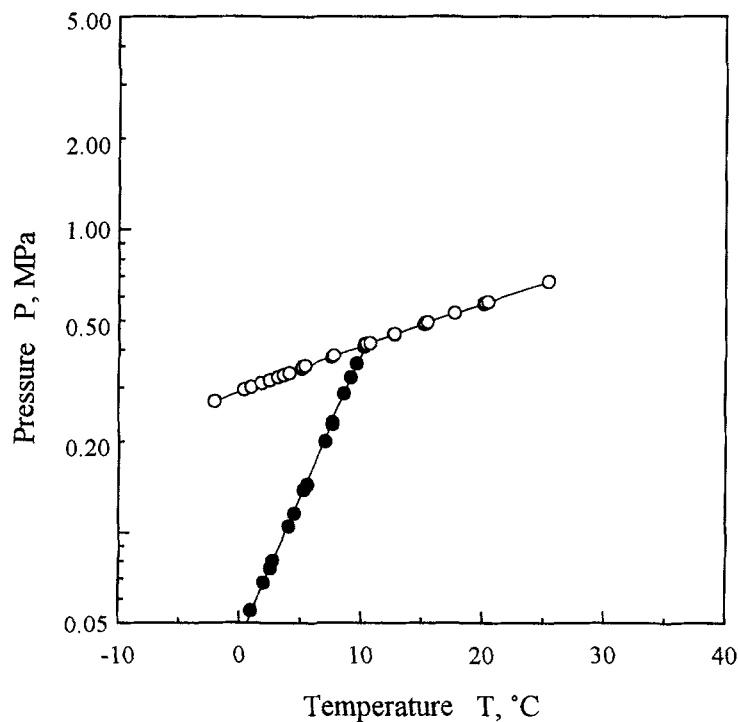

Fig. 4. Phase equilibrium of the HFC-134a/water system.

To calculate the thermodynamic properties, the following equation of the equilibrium pressure of the clathrate was used,

$$\ln(P) = a/T + b \quad (1)$$

where P is the equilibrium pressure in MPa, T is the equilibrium temperature in K, and a and b are constants. Constants a and b were determined using least-squares fitting from the experimental data for the clathrate formation line and are listed in Table I. Errors in Table I are average values of relative deviations between the experimental pressures and the calculated pressures using Eq. (1) for the clathrate formation line of each refrigerant.

The critical decomposition temperature (T_C) and the critical decomposition pressure (P_C) were not directly observed in this experiment. These were obtained from the point where the clathrate formation line and the condensation line intersect. These were calculated from Eq. (1) for both the clathrate formation line and the condensation line and are also listed in Table I. The critical decomposition temperature (T_C) of the clathrate of

Table 1. T_C , P_C , and ΔH of HFC Refrigerant Clathrates

Refrigerant	T_C (K)	P_C (MPa)	Constant		Error (%)	ΔH at T_C (kJ/mol)
			a	b		
HFC-32	294.09	1.489	-8612.56	29.681	1.5	54.2
HFC-125	284.39	0.944	-16232.8	57.022	3.1	108.2
HFC-134a	283.49	0.417	-16893.0	58.714	0.4	124.1
R410A	293.43	1.428	-9836.73	33.879	3.7	73.7
R407C	287.45	0.770	-13872.3	47.999	2.2	103.4

HFC-32 in this experiment is greatly different from that reported in the literature [3], which was cited from a report in 1890, for which the measurement method is unknown. Differences of the critical decomposition temperature (T_C) and the critical decomposition pressure (P_C) of the clathrate of HFC-134a between this experiment and the literature [5] are 0.29 K and 0.002 MPa, respectively. These differences are estimated to be technical deviations in this measurement method.

Among single refrigerants, both the T_C and the P_C of HFC-32 were higher than those of HFC-125 and HFC-134a. The slope of the clathrate formation line of HFC-32 in Eq. (1) was less steep than those for HFC-125 and HFC-134a. This difference of the slope of the clathrate formation line in Eq. (1) could be caused by the difference of structure of crystals.

The enthalpy of dissociation (ΔH) which is the heat of decomposition of the clathrate into gas can be calculated from Eq. (2) with the Clausius-Clapeyron equation and the slope of the clathrate formation line [8, 9].

$$\Delta H = -RZd \ln(P)/d(1/T) \quad (2)$$

where R is the gas constant and Z is the compressibility factor. When the clathrate formation pressure is sufficiently low and the compressibility factor Z is assumed to be 1.00 [9], the enthalpy of dissociation (ΔH) of the clathrate of a single refrigerant can be approximately represented as Eq. (3) from the clathrate formation line [Eq. (1)].

$$\Delta H = -aR \quad (3)$$

As HFC refrigerants have relatively high critical decomposition pressures (P_C), the enthalpy of dissociation (ΔH) of the clathrate of a single refrigerant was calculated from Eq. (4) at the critical decomposition point using a Z -value from REFPROP Version 5.0.

$$\Delta H = -aRZ \quad (4)$$

Using Eq. (4) and Table I, the ΔH at the critical decomposition point was calculated and is also listed in Table I. Judging from values of the enthalpy of dissociation (ΔH) [9], it is confirmed that HFC-32 forms crystals of structure I, and HFC-125 and HFC-134a form crystals of structure II.

4. RESULTS FOR MIXED REFRIGERANTS

The phase equilibria of systems containing water and the mixtures R410A and R407C composed of HFC-32, HFC-125, and HFC-134a are shown in Figs. 5 and 6, respectively. The plots of the condensation line are represented by the points \circ , and the plots of the clathrate formation line are represented by the points \bullet . Near-azeotropic R410A has almost the same bubble- and dew-point pressures at constant temperature, and the obtained values of the condensation line in the R410A/water system agree well with values predicted by REFPROP Version 5.0. But nonazeotropic R407C, which is a mixture of almost half R410A and half HFC-134a, has

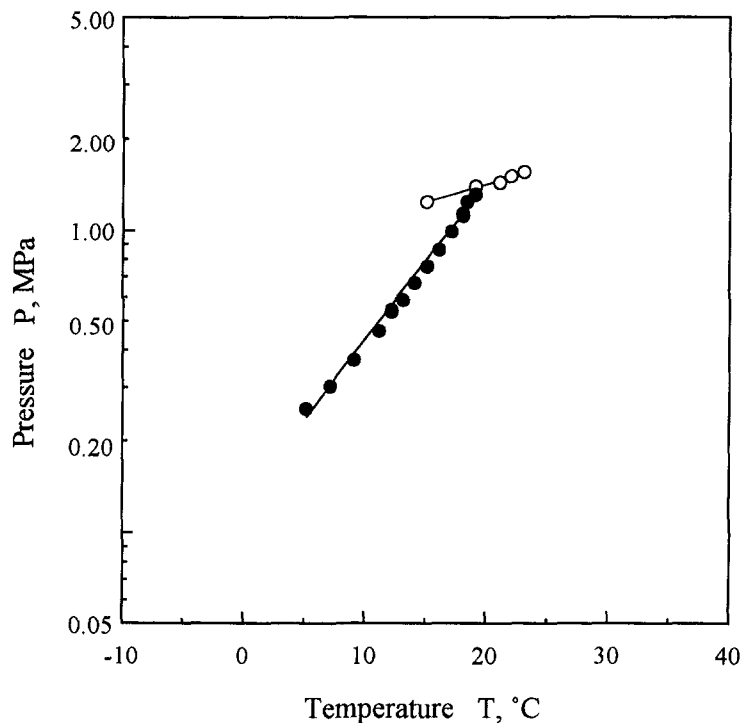

Fig. 5. Phase equilibrium of the R410A/water system.

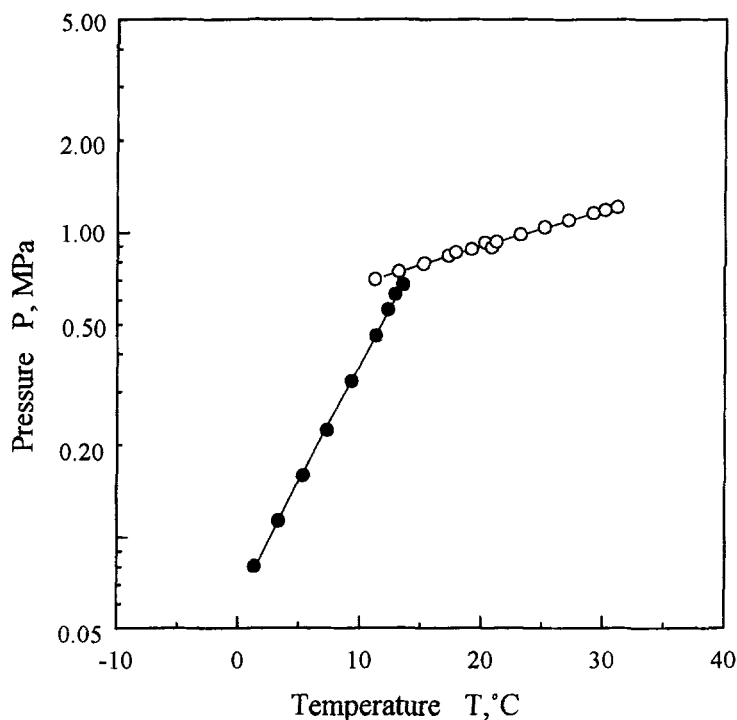

Fig. 6. Phase equilibrium of the R407C/water system.

a higher pressure in saturated liquid than that in saturated vapor at constant temperature, and the obtained values of the condensation line in the R407C/water system are between the dew- and bubble-point curves predicted by REFPROP Version 5.0.

Constants a and b of the equilibrium pressure of the clathrate formation line, the critical decomposition temperature (T_c), the critical decomposition pressure (P_c), and the apparent enthalpy of dissociation of the clathrate (ΔH) at the critical decomposition point of R410A and R407C were calculated using similar methods to those used for single refrigerants. These values are also listed in Table I.

The measured critical decomposition points of the HFC refrigerants clathrates are shown in Fig. 7. In this experiment, the critical decomposition point of R410A is located on the straight line connecting those of HFC-32 and HFC-125, and the T_c and P_c of R410A are very close to those of the single refrigerant HFC-32. Also, the critical decomposition point of R407C is close to the straight line connecting those of R410A and

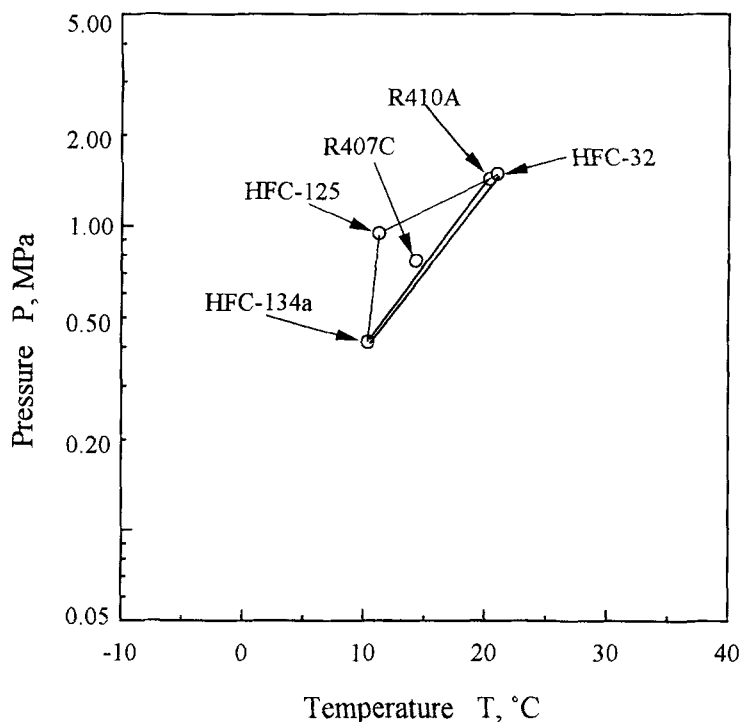

Fig. 7. Critical decomposition points of the HFC refrigerant clathrates.

HFC-134a. The critical decomposition point of the HFC refrigerant clathrates of any composition composed of HFC-32, HFC-125, and HFC-134a might be estimated from Fig. 7. This phenomenon should be checked in other mixtures that the T_c and P_c of a mixture would be close to those of one of its components or on a straight line between the two components.

5. CONCLUSIONS

The phase equilibria between water and HFC alternative refrigerants such as HFC-32, HFC-125, HFC-134a, and their mixtures, R410A and R407C, were obtained, and the critical decomposition points of those clathrates were determined. The critical decomposition points of mixed refrigerants were located close to on the straight line connected by those of the constituent refrigerants.

The critical decomposition temperatures in this experiment were about 20°C in the case of R410A and about 14°C in the case of R407C. These

mixtures can form clathrate compounds with water below these critical decomposition temperatures. It is found that R407C and R410A form clathrate compounds with water under the evaporating temperature condition in the refrigeration cycle of air-conditioners and heat pumps, because the usual evaporating temperature is lower than about 14°C.

REFERENCES

1. ASHRAE Standard, *ANSI/ASHRAE 34-1992 and Addenda* (1995).
2. M. Matsuo, M. Tagashira, and Y. Yoshida, *Proc. 17th Japan Symp. Thermophys. Prop.* 227 (1996).
3. D. W. Davidson, in *Water, a Comprehensive Treatise, Vol. 2*, F. Franks, ed. (Plenum, New York/London, 1973).
4. Allied-Signal, *WO93/00412* (1993) and *WO93/04139* (1993).
5. M. Oowa, M. Nakaiwa, T. Akiya, H. Fukuura, K. Suzuki, and M. Ohsuka, *Proc. 25th IECEC* 4:269 (1990).
6. J. P. Lederhos, A. J. Mehta, G. B. Nyberg, K. J. Warn, and E. D. Sloan, *AIChE J.* **38**:1045 (1992).
7. M. L. Huber, J. S. Gallagher, M. O. McLinden, and G. Morrison, *NIST Thermodynamic Properties of Refrigerants and Refrigerant Mixtures Database, NIST 23 (REFPROP), Version 5.0* (Nat. Inst. Stds. Tech., Boulder, CO, 1996).
8. J. H. van der Waals and J. C. Platteeuw, *Nature* **183**:462 (1959).
9. A. J. Barduhn, H. E. Towilson, and Y. C. Hu, *AIChE J.* **8**:176 (1962).